

## "RELAX 1"

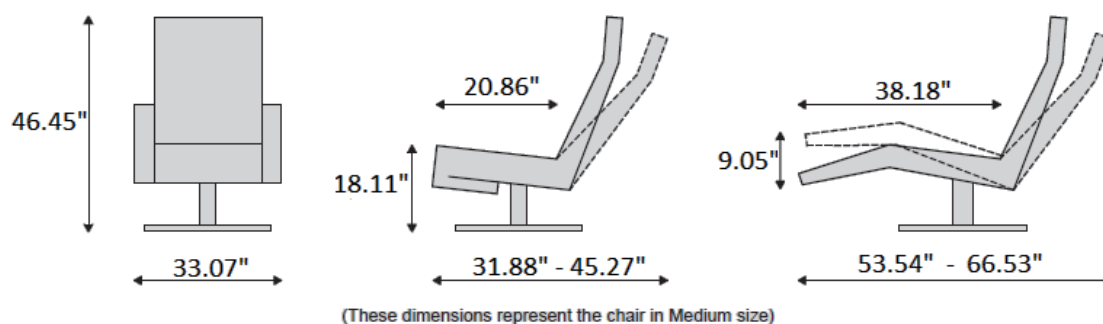

The recliner is available in 4 different sizes - dimensions noted below for the Medium size (as shown in showroom)



### ADDITIONAL SIZE OPTIONS:

- Extra Small: 0.78" less in seat height / 1.57" less in seat depth - subtract from specs noted above
- Small: 0.78" less in seat height / 0.78" less in seat depth - subtract from specs noted above
- Medium: Dimensions as noted in specs above
- Large: 0.78" more in seat height / 0.78" more in seat depth - add to specs noted above

## "RELAX 1"









### THREE MOTOR MECHANISM:

These three motors manage the back, footrest and "heart balance" features. The back motor ensures that the backrest can be adjusted seamlessly. The motors for the footrest and heart balance feature work in combination with each other. The first motor extends the footrest from beneath the chair. When the footrest is completely extended, the second motor switches on. The second motor tilts both the footrest and the seat backwards until the "heart balance" position has been achieved. The "heart balance" position is experienced as extremely relaxing. This is because the legs, heart and head are situated along an imaginary horizontal line. This is the position in which the heart pumps with minimum effort to provide blood circulation. The motors are battery-powered so there will be no cable connection between the chair and the wall mount. Once every month (or by heavy use when the battery is empty) the battery needs to be recharged. The buttons for controlling the motors are mounted inside the arm (in front of the chair on the left side). Finally, the backrest can be seamlessly adjusted, and the top customized to provide desired head and neck support (top swing).

CONTROL: Integrated into the front left side of the chair

### Base

The recliner is also available with a different disc or five-leg base.

		
Base 21 - Chrome	Base 22 - Grey	Base 23 - Black
		
Base 25 - Stained	Base 27 - Stainless Steel	Base 45 - Upholstered
		
Base 83 - Aluminium	Base 84 - Black/Aluminium	Base 85 - Stainless Steel

WOOD BASE / UPHOLSTERED BASE WILL BE ADDITIONAL COST