

## "RELAX 2"

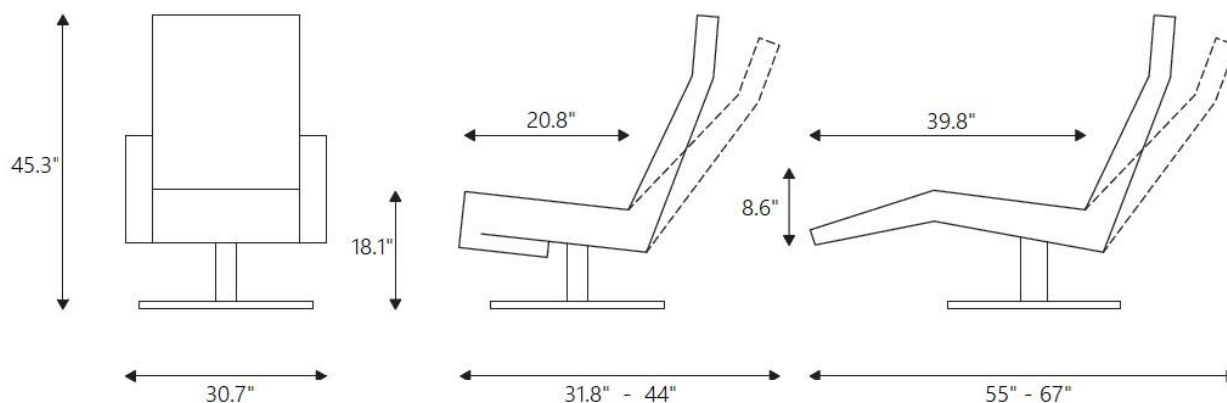

The recliner is available in 4 different sizes - dimensions noted below for the Medium size (as shown in showroom)



### ADDITIONAL SIZE OPTIONS:

- Extra Small: 0.78" less in seat height / 1.57" less in seat depth - subtract from specs noted above
- Small: 0.78" less in seat height / 0.78" less in seat depth - subtract from specs noted above
- Medium: Dimensions as noted in specs above
- Large: 0.78" more in seat height / 0.78" more in seat depth - add to specs noted above

## "RELAX 2"









### THREE MOTOR MECHANISM:

The recliner is delivered with standard electric operation from three motors: one for the back rest, one for the footrest, and one to move seat and footrest into the Heart Balance position. The so-called Heart Balance feature means that feet and heart are arranged along an imaginary horizontal line. This results in minimal effort for the heart, and is experienced as extremely restful. The backrest can be adjusted without extending the footrest. The back can also be adjusted to any position after the footrest has been extended. The top part of the back rest, which supports the head, can be adjusted from back to front (top swing), so that the head will be supported comfortably in any position.

CONTROL: Integrated into the front left side of the chair

### Base

The recliner is also available with a different disc or five-leg base.

		
Base 21 - Chrome	Base 22 - Grey	Base 23 - Black
		
Base 25 - Stained	Base 27 - Stainless Steel	Base 45 - Upholstered
		
Base 83 - Aluminium	Base 84 - Black/Aluminium	Base 85 - Stainless Steel

WOOD BASE / UPHOLSTERED BASE WILL BE ADDITIONAL COST