



NEW
NOWOŚĆ
NEU

VARIO 3

PERFECT FOR SUPERMARKETS

 **IGLOO**
MORE THAN COOLING

VARIO 3

PERFECT FOR SUPERMARKETS



IGLOO
MORE THAN COOLING

en At IGLOO we know that cooling equipment enhances the functionality of large format stores. Guided by the needs of our clients we have created the VARIO family of multidecks. Thanks to the offer of devices with a wide range of functionalities, the VARIO device creates a new philosophy of sales.

pl W firmie IGLOO wiemy, że urządzenia chłodnicze podnoszą funkcjonalność wielkopowierzchniowych sklepów. Kierując się potrzebami naszych klientów stworzyliśmy rodzinę regałów marketowych VARIO. Dzięki oferowanym urządzeniom o szerokim zakresie funkcjonalności urządzenia Vario tworzą nową filozofię sprzedaży.

de Wir bei IGLOO wissen es, dass Kühlgeräte die Funktionalität der großflächigen Supermärkte optimieren. Um den Bedürfnissen unserer Kunden entgegenzukommen, haben wir die Supermarktregale VARIO entwickelt. Dank den zahlreichen funktionalen Lösungen schaffen die Geräte Vario eine neue Verkaufsphilosophie.

NOWE VARIO 3 – NOWE ROZWIĄZANIA

Stworzyliśmy nową linię regałów marketowych VARIO 3 wprowadzając udogodnienia, które spełniają zapotrzebowanie naszych Klientów.

NEW VARIO 3 - NEW SOLUTIONS

We have created a new line of VARIO 3 by introducing amenities which meet our customers' needs and expectations.

VARIO 3 - NEUE LÖSUNGEN

Wir haben eine neue Linie von VARIO 3 geschaffen, die den Bedürfnissen und Erwartungen unserer Kunden entsprechen



ONE VARIO, MANY VARIANTS

JEDNO VARIO, WIELE WARIANTÓW
EIN VARIO VIELE VARIANTEN

DP

Sliding doors with combined glass
Drzwi przesuwne z szybami zespolonymi
Schiebetür mit Sicherheitsglas

DU

Hinged doors with combined glass
Drzwi uchylne z szybami zespolonymi
Tür mit Isolierverglasung, klappbar

M

Freezing passive hinged doors
Mroźnicze, pasywne drzwi uchylne
Tiefkühl-Passiv-Drehtüren

VE

Device is designed for storing vegetables and fruits
Urządzenie przeznaczone do przechowywania warzyw i owoców
Vorrichtung zur Aufbewahrung von Obst und Gemüse

3 BENEFITS 3 KORZYŚCI / 3 VORTEILE

en SMART INTERNAL AIR CIRCULATION SYSTEM

- curtain system 3S & 2S

- Reduction of cooling power demand by 10%
 - Evaporator surface increased by 55%
 - Automatic fan speed control system
- Energy-saving ECM fans (quiet and waterproof) which reduce the energy consumption of fans by up to 60%

pl INTELIGENTNY SYSTEM OBIEGU POWIETRZA

WEWNĘTRZNEGO - system 3S oraz 2S

- Zmniejszenie zapotrzebowania na moc chłodniczą regału o 10%
 - powierzchnia parownika zwiększona o 55%
 - system automatycznej regulacji prędkości wentylatorów
- Energooszczędne wentylatory ECM (ciche i wodoszczelne), które redukują zużycie energii wentylatorów aż o 60%

de SMART INTERNAL AIR CIRCULATION SYSTEM

- Luftschleier-System 3S & 2S

- Reduzierung des Kühlleistungsbedarfs um 10%
 - Verdampferfläche um 55% erhöht
 - Automatische Steuerung der Lüftergeschwindigkeit
- Energiesparende ECM-Lüfter (leise und wasserdicht), die den Energieverbrauch von Lüftern um bis zu 60% senken

en NO DEFROST SYSTEM

combining with the MULTICOOL IGLOO inverter aggregate additionally gives up to 45% energy savings

pl NO DEFROST SYSTEM

w połączeniu z agregatem inwerterowym MULTICOOL IGLOO dodatkowo daje nawet 45% oszczędności energii

de NO DEFROST SYSTEM

kombiniert mit dem MULTICOOL IGLOO Inverter-Aggregat ergibt zusätzlich eine Energieeinsparung von bis zu 45%

VARIO 3

en MAXIMUM PRODUCT VISIBILITY AND ESTHETIC DESIGN

- Over 85% of the multideck surface area is dedicated to product exposition
- Modern transparent door and handle system
- Lack of visible connecting elements both inside and outside the device
- Easy to clean

SMART INTERNAL AIR CIRCULATION SYSTEM 3 CURTAINS



pl MAKSYMALNA WIDOCZNOŚĆ PRODUKTÓW I ESTETYCZNY DESIGN

- Ponad 85% powierzchni regału dedykowana jest na ekspozycje produktów
- Nowoczesny transparentny system drzwi i uchwytów
- Brak widocznych elementów łączących zarówno wewnątrz jak i na zewnątrz urządzeń
- Łatwość w utrzymaniu w czystości

de MAXIMALE PRODUKTSICHTBARKEIT UND ÄSTHETISCHES DESIGN

- Über 85% des Kühlregals sind für die Produktausstellung bestimmt
- Modernes transparentes Tür - und Griffsystem
- Keine sichtbare Verbindungselemente innerhalb und außerhalb des Gerätes
- Einfach zu säubern

ECO FRIENDLY

en In VARIO 3 we have used energy-efficient air fans. Thanks to the use of electronically commutated engines we've lowered the cost of electricity consumption by 55%. The levels of noise generated by the fans is also lower, and their lifespan is much longer. In addition, the energy-efficient fans have an electronic control system that can be easily regulated.

pl W VARIO 3 zastosowaliśmy energooszczędne wentylatory powietrza. Dzięki wykorzystaniu silników komutowanych elektronicznie obniżyliśmy koszty zużycia energii elektrycznej o 55%. Niższy jest także poziom hałasu emitowanego przez wiatraki, a ich żywotność znacznie dłuższa. Dodatkowo energooszczędne wentylatory posiadają elektroniczny układ sterujący, który można łatwo regulować.

de Unser VARIO 3 wurde mit energiesparenden Lüftern ausgestattet. Dank dem Einsatz von elektronisch kommutierten Motoren konnten wir den Stromverbrauch um 55% reduzieren. Der Lärmpegel der Lüfter wurde reduziert und die Lebensdauer der Lüfter erheblich verbessert. Zusätzlich verfügen die energiesparenden Lüfter über ein elektronisches Steuersystem, der einfach geregelt werden kann.



SAVE ENERGY
55%

SMART INTERNAL AIR CIRCULATION SYSTEM - 3 CURTAINS



ABOUT VARIO 3

ATTRIBUTES

ATRYBUTY / ATTRIBUTE

Smart internal air circulation system
- 3 curtains (3S)
Inteligentny system obiegu powietrza wewnętrzznego
- 3 kurtyny (3S)
Intelligentes internes Luftzirkulationssystem
- 3 Vorhänge (3S)

Electronic temperature controller
Elektroniczny regulator temperatury
Elektronische Temperaturregelung

Night roller blinds
Roleta nocna
Nachttollo

For use with an external cooling unit
Urządzenie na agregat zewnętrzny
Für externes Aggregat geeignet

Price strips
Listwy cenowe
Scannerleisten

Additional illumination of shelves
Dodatkowe podświetlenie półek
Zusätzliche Beleuchtung der Ablagen

Side panels made of double combined
tempered glass (full side panels available)
Boki szklane z szyby zespolonej
(dostępne pełne boki)
Seitenteile aus Sicherheitsglas
(zur Wahl volle Seitenteile)

Exposition shelves with height
and angle adjustment
Półki ekspozycyjne z możliwością
regulacji wysokości i kąta zawieszenia
Auslagen, Höhen-
und Neigungsverstellung möglich

NEW

VARIO 3

RECOMENDED WITH
MultiCool
INVERTER UNIT



3M1 (-1/+5°C) / 3M2 (-1/+7°C) / 3H1 (+1/+10°C)

R448 / R449 / R744



1.25 1.88 2.50 3.13 3.75



REMOTE



en VARIO 3 is the latest line of refrigerated multidecks introducing the latest technological innovations to meet the needs of our customers adapted to large-format stores.

pl VARIO 3 to najnowsza linia regałów chłodniczych wprowadzających najnowsze innowacje technologiczne spełniające zapotrzebowanie naszych Klientów dostosowane do sklepów wielkopowierzchniowych.

de VARIO 3 ist die neueste Linie von Kühlregalen, die die neuesten technologischen Innovationen einführt, um die Bedürfnisse unserer Kunden zu erfüllen, die an großformatige Geschäfte angepasst sind.



NEW

VARIO 3 DU

RECOMENDED WITH
MultiCool
INVERTER UNIT



3M1 (-1/+5°C) / 3M2 (-1/+7°C) / 3H1 (+1/+10°C)

R448 / R449 / R744



1.25 1.88 2.50 3.13 3.75



REMOTE



en Hinged doors with combined glass - door soft closing system (DU)

pl Drzwi uchylne z szymbami zespolonymi - system miękkiego domykania drzwi (DU)

de Tür mit Isolierverglasung, klappbar - Soft - Close - System (DU)

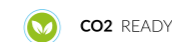

NEW

VARIO 3 DP

RECOMENDED WITH
MultiCool
INVERTER UNIT

3M1 (-1/+5°C) / 3M2 (-1/+7°C) / 3H1 (+1/+10°C)

R448 / R449 / R744

1.25 1.88 2.50 3.13 3.75

REMOTE



en Sliding doors with combined glass – door soft closing system (DP)

pl Drzwi przesuwne z szybami zespolonymi – system miękkiego domykania drzwi (DP)

de Schiebetür mit Sicherheitsglas – Soft – Close – System (DP)



NEW

VARIO 3 VE

RECOMENDED WITH
MultiCool
INVERTER UNIT

3M1 (-1/+5°C) / 3M2 (-1/+7°C) / 3H1 (+1/+10°C)

R448 / R449 / R744

1.25 2.50 3.75

REMOTE



en VARIO 3 VE is a device which completes the line of multidecks for large surface stores for storing vegetables and fruits. Equipped with a night blind.

pl VARIO 3 VE jest urządzeniem uzupełniającym linię regałów do sklepów wielkopowierzchniowych przeznaczony do przechowywania warzyw i owoców. Wyposażony jest w roletę nocną.

de VARIO 3 VE ist ein Gerät, das die Regallinie für großflächige Geschäfte zur Aufbewahrung von Gemüse und Obst ergänzt. Mit Nachttrolle ausgestattet.

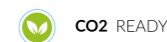

NEW

VARIO 3 M

RECOMMENDED WITH
MultiCool
INVERTER UNIT



3L1(-22/-18°C)

R448 / R449 / R744



1.56 2.34 3.12 3.90



REMOTE

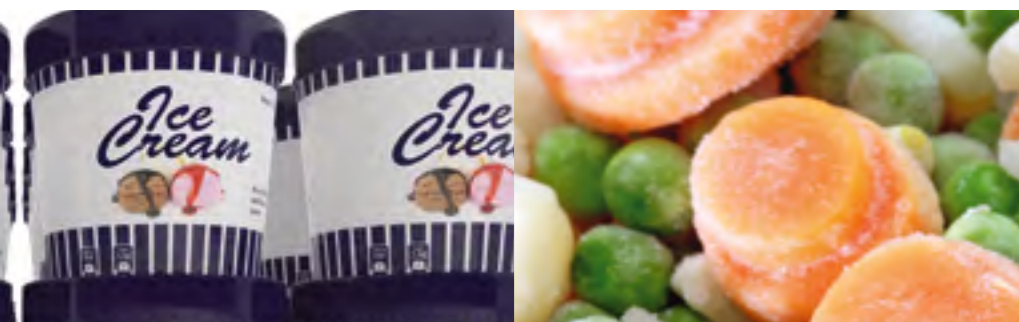

en VARIO 3 M is another version of the latest multideck line adapted to large surface stores, a freezing device adapted to store products at low temperatures. The hinged door system is made in the Energy Free glass technology thanks to which we obtain a high level of energy efficiency while maintaining maximum transparency of the exhibition space.

pl VARIO 3 M to kolejna wersja najnowszej linii regałów dostosowana do sklepów wielkopowierzchniowych, urządzenie mroźnicze, dostosowane do przechowywania produktów w niskich temperaturach. System drzwi uchylnych jest wykonany w technologii Energy Free glass, dzięki której uzyskujemy wysoki poziom energooszczędności przy zachowaniu maksymalnej transparentności przestrzeni ekspozycyjnej.

de VARIO 3 M ist eine weitere Version der neuesten Regallinie für großflächige Geschäfte, ein Gefriergerät für die Lagerung von Produkten bei niedrigen Temperaturen. Das Drehtürsystem wurde mit Non-energy Glasüren hergestellt, dank der wir eine hohe Energieeffizienz bei maximaler Transparenz der Ausstellungsfläche erreichen.



IGLOO
MORE THAN COOLING

en We are one of the most dynamically-growing producers of commercial cooling solutions in Europe. We have built a brand whose innovative products, quality and design are recognized both in Poland and on the international market.

pl Jesteśmy jedną z najdynamiczniej rozwijających się firm wśród producentów przemysłowych rozwiązań chłodniczych w Europie. Zbudowaliśmy markę, która dzięki innowacyjnym produktom, jakości oraz stylistyce, zyskała uznanie zarówno w Polsce, jak również na rynkach międzynarodowych.

de Wir sind eine der sich am dynamischsten entwickelnden Firmen unter Produzenten von Industriekühlgeräten in Europa. Wir haben eine Marke gegründet, die dank innovativen Produkten, Qualität und Stilistik sowohl in Polen, als auch auf dem internationalen Markt anerkannt ist.

VARIO 3

PERFECT FOR SUPERMARKETS

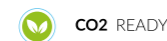

VARIO 3 L 90

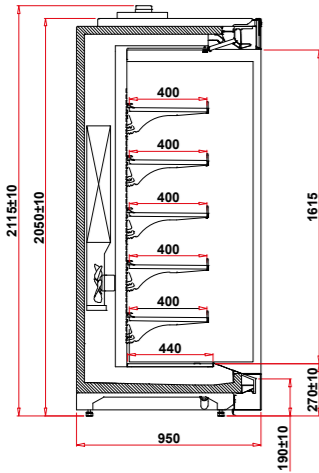

VARIO 3 L 110

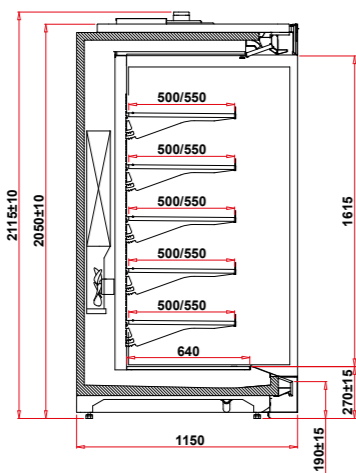

VARIO 3 DU L 90

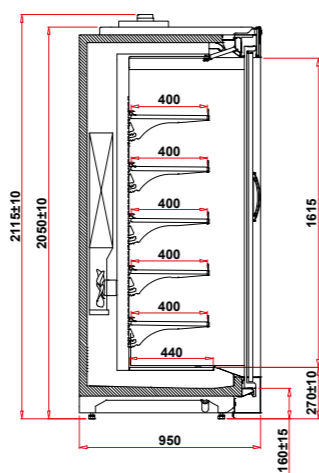

VARIO 3 DU L 110

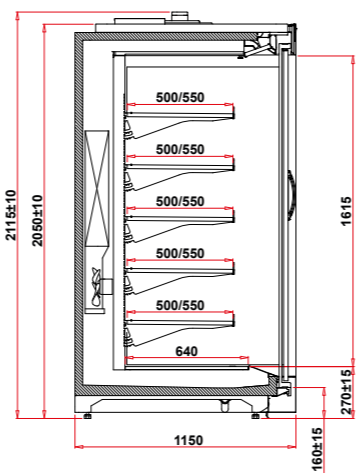

VARIO 3 H 90

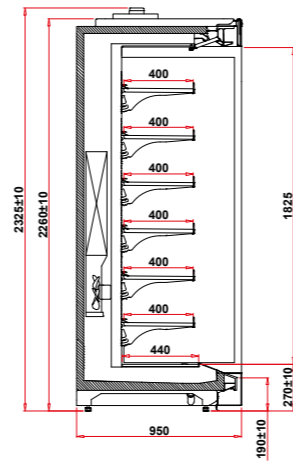

VARIO 3 H 110

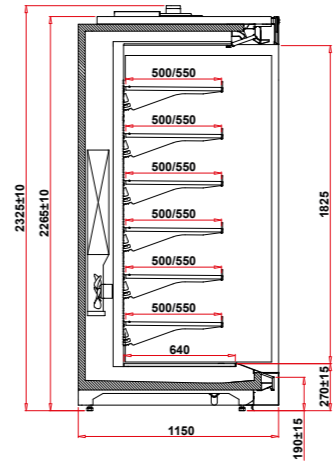

VARIO 3 DU H 90

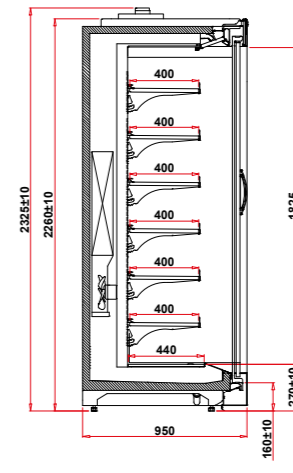

VARIO 3 DU H 110

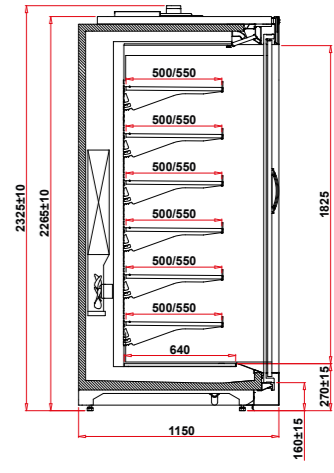

VARIO 3 DP L 90

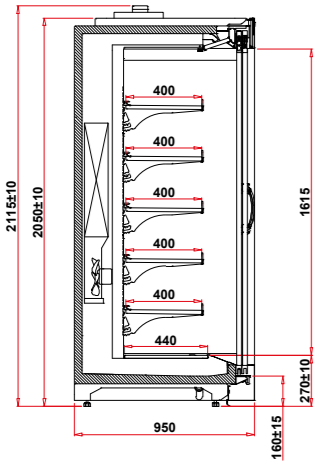

VARIO 3 DP L 110

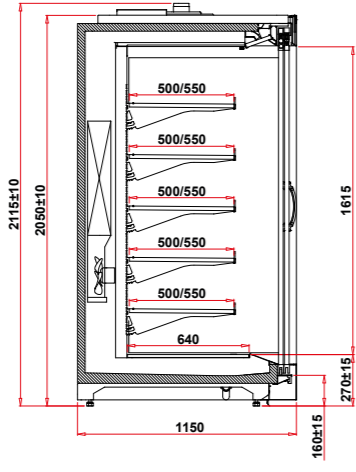

VARIO 3 VE L 90

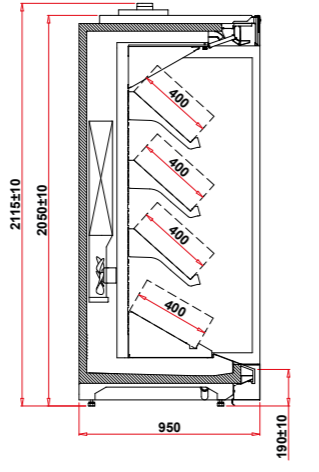

VARIO 3 VE L 110

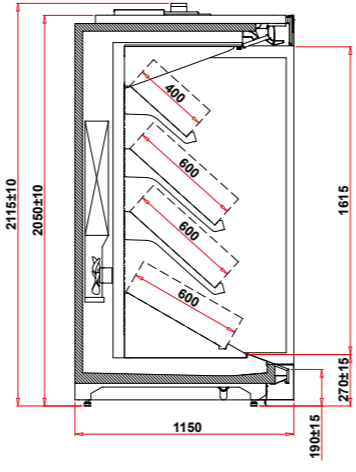

VARIO 3 DP H 90

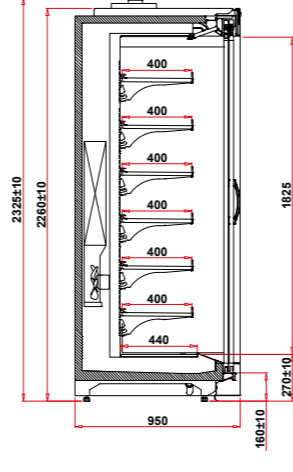

VARIO 3 DP H 110

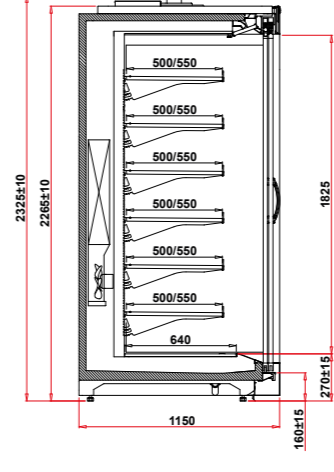

VARIO 3 VE H 90

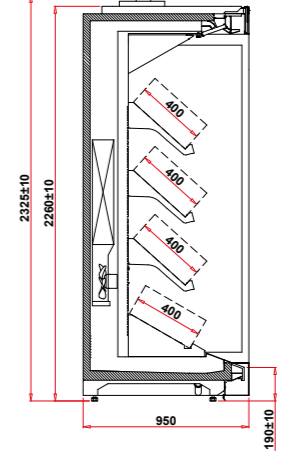

VARIO 3 VE H 110

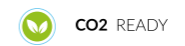
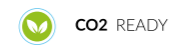
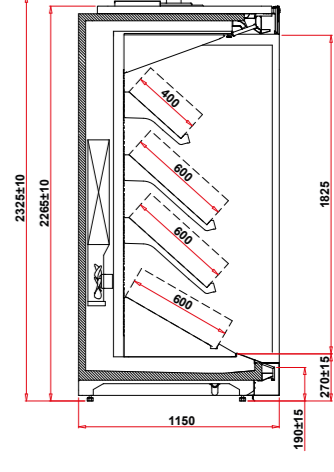



IGLOO
MORE THAN COOLING

IGLOO.PL



IGLOO Stary Wiśnicz 289
32-720 Nowy Wiśnicz



tel +48 146621910



info@igloo.pl



In der Helle 2
58566 Kierspe
Deutschland

www.igloo-germany.de